

Tyskland

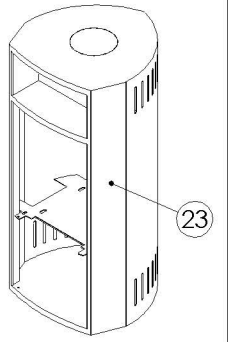
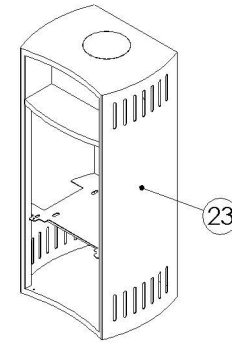
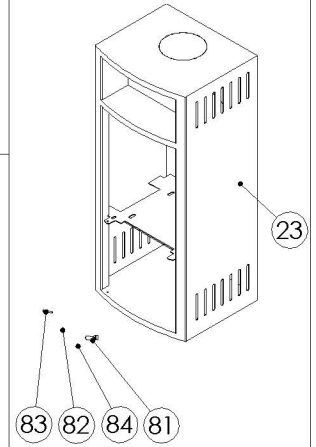
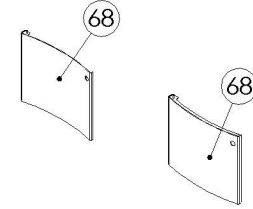
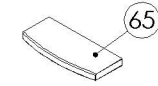
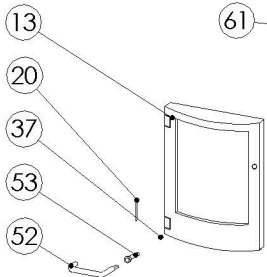
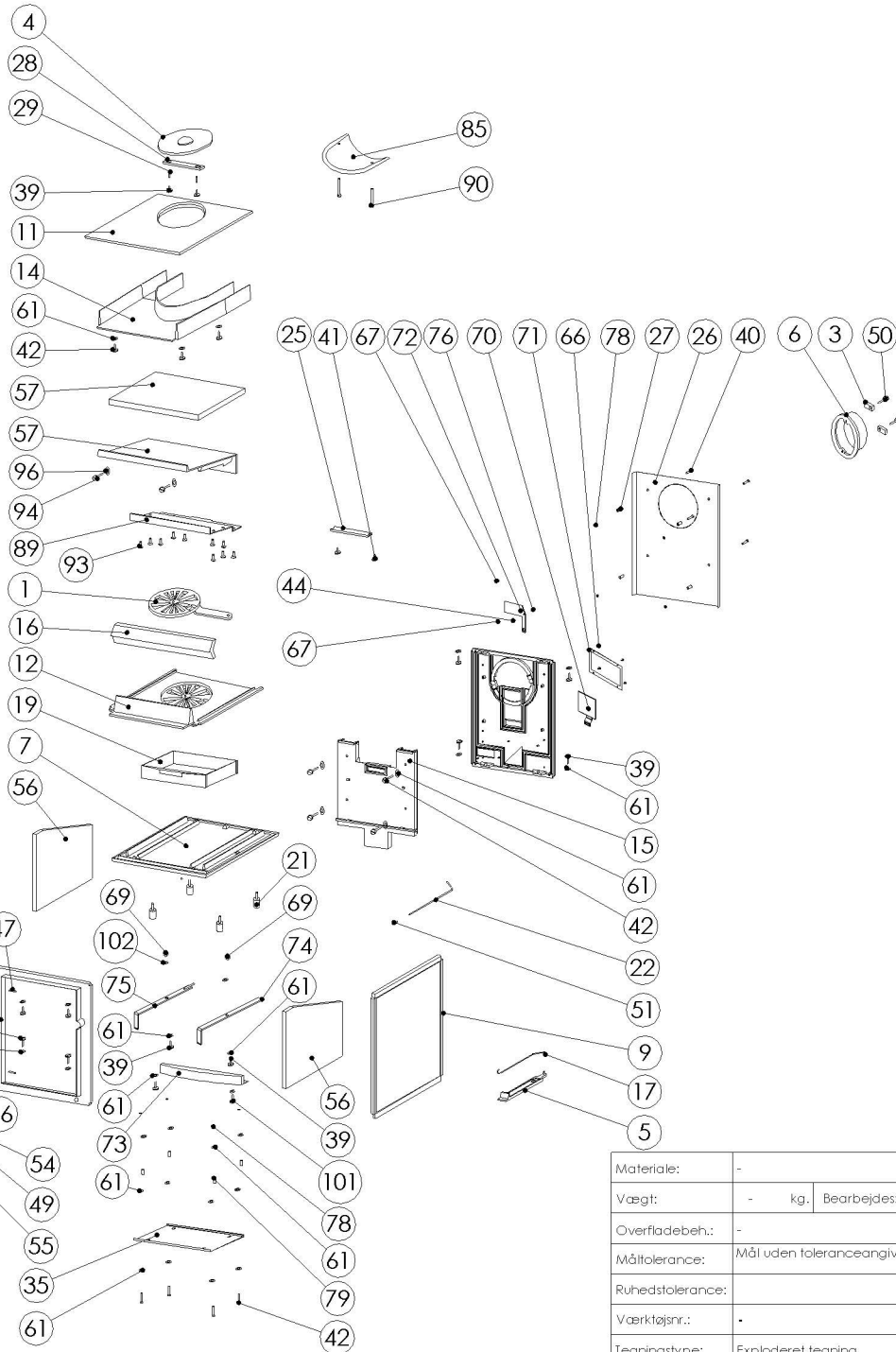
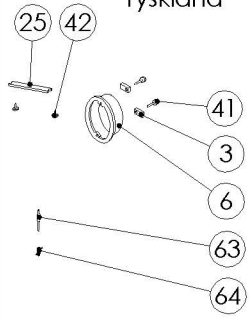

i	Tilføjet Pos. 46 Jernnit.	RSV	24.08.2006
h	Fjernet pos. 46 bolt.	RSV	08.09.05
g	Ændret pos. nr. på skrue til kuglespærre DIN.	RSV	26.08.05
f	Tilføjet 2 stk. skiver under fronkant.	RSV	23.09.04
e	Påført tyske ovne og fjernet møtriker for røgskål	RSV	09.10.2002
Rev.	Revisionstekst:	Sign.:	Dato:

Materiale:	-
Vægt:	- kg. Bearbejdes: -
Overfladebeh.:	- m ²
Måltolerance:	Mål uden toleranceangivelse
Ruhedstolerance:	
Værktøjsnr.:	-
Tegningstype:	Exploderet tegning

Titel:
Reservedelstegning
Morsø 4700

Konstr.:	RSV	17.10.2001
Frigivet:		
Tegn.format:		A3
Måforhold:		1:20
Varenr.:		-
Tegningsnr.:		4600-522 i