

morsø



By appointment to The Royal Danish Court

morsø

Installation and Operating Instructions

3410, 3440 & 3450

For use in North America



Congratulations on the purchase of your new Morsø stove!

Morsø, which is the largest supplier for the Danish market, has manufactured stoves of the highest quality since 1853. By following the instructions overleaf, we are sure that you will enjoy the use and the benefits of your stove for many years to come.

Contents

1.0	Installation of your Morsø stove	Page no.
1.1	Unpacking the stove	4
1.2	Checking loose parts in the stove	5
1.3	The chimney / flue system	6
1.4	Flue connection	6
1.5	Connection to the existing chimney	8
1.6	Positioning the stove	10
2.0	Operation	12
2.1	Before you start firing	12
2.2	Lighting & loading intervals	13
3.0	Maintenance	16
3.1	Exterior maintenance	16
3.2	Internal maintenance	16
3.3	Cleaning the stove & the flue	18
3.4	Leaving the stove for extended periods	19
3.5	Parts diagram	20
3.6	Parts list	21

Read this entire manual before you install and use your new room heater. If this room heater is not properly installed, a house fire may result. To reduce the risk of fire, follow the installation instructions. Failure to follow instructions may result in property damage, bodily injury, or even death.

Contact local building officials about restrictions and installation inspection requirements in your area.

Save these instructions

Optional Accessories

A wide range of accessories (such as handling gloves, fireside tools, glass cleaner and heat-proof paint) are available for use with your Morsø stove. They help with day-to-day running and maintenance. Contact your Morsø dealer for more information.

The Morsø 3410 owl, 3440 and 3450 meet the U.S. Environmental Protection Agency's emission limits for wood heaters sold on or after July 1, 1990



The Morsø 3410 owl, 3440 and 3450 are listed by OMNI-Test Laboratories, Inc. The test standards are ANSI/UL-1482 for the United States and ULC S627 for Canada.

The stove is listed for burning wood only. Do not burn other fuels.

Under specific test conditions this heater has been shown to deliver heat at rates ranging from 8400 to 23600 Btu's.

Cast iron

Cast iron is a live material. There are no two ovens that are identical. This is partly due to the tolerances of the casting process, partly because the ovens are a work of craftsmanship. Minor unevennesses may also occur in the cast iron surface.

1.0 Installation of your Morsø stove

Installation of woodburning stoves must be safe and legal.

If your Morsø stove is not installed correctly, it may cause a house fire. To reduce the risk of fire, the installation instructions must be followed carefully. Contact the local building officials about restrictions and installation inspection in your area.

Before you start installing your stove, make sure that:

- The stove and chimney connection are placed far enough from combustible materials to meet all clearance requirements.
- The floor protection must be adequate and must be made correctly according to the requirements.

All necessary approvals are needed from the local building officials.

The data plate, which is located on the back of the stove, provides information regarding safety testing information, name of certified testing laboratory, and installation requirements.

Installation requirements vary in different districts, and the local building officials have the final authorization to approve your installation. You should discuss the installation with them before beginning. Please ask your dealer for further information.

Do not connect to any air distribution duct or system.

Important: If the installation instructions are not followed carefully, it may cause dangerous situations like chimney - and house fires. Follow the instructions carefully and do not deviate from them as it may cause injuries to people or property.

1.1 Checking loose parts in the stove

After unpacking, check that the center grate (in the centre of the fire bed) and the fire bricks are firmly in position and have not shifted in transit. Check also that the air control works freely.

Standard Accessories

Poker, ceramic flue connection gasket and riddling tool are standard accessories, and can usually be found in the ashpan or firebox area.

1.2 The chimney / flue system

Note that the flue system must be independently secured and must not rely on the stove for support.

The stove must not be connected to a chimney flue serving any other appliance.
(Several flues may run up a single chimney stack; use one flue-way per appliance).

Use a residential type masonry or listed type HT factory-built chimney.

High Temperature (H.T.) Chimney Standard UL-103-1985 (2100° F.) for the USA, and High Temperature (650°C) Standard ULC S-629 for Canada.

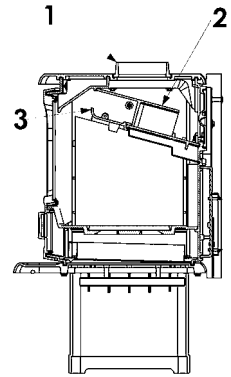

The internal dimensions of the chimney connector and chimney must not be less than 6 inches diameter (or equivalent cross section), and should not be significantly larger than this. Too large a section will tend to allow the flue gases to cool excessively, causing sluggishness or unpredictability in the stove's performance.

We recommend the length of the chimney system should be at least 16 feet (not required) above the stove in normal domestic situations, measured from the flue collar to the top of the chimney.

Local conditions like for example - roof constructions, large trees nearby and high altitude, may influence the chimney draft and height. Therefore, contact the local professional chimney sweep or your Morsø dealer.

Typical factory-built or masonry chimney installations

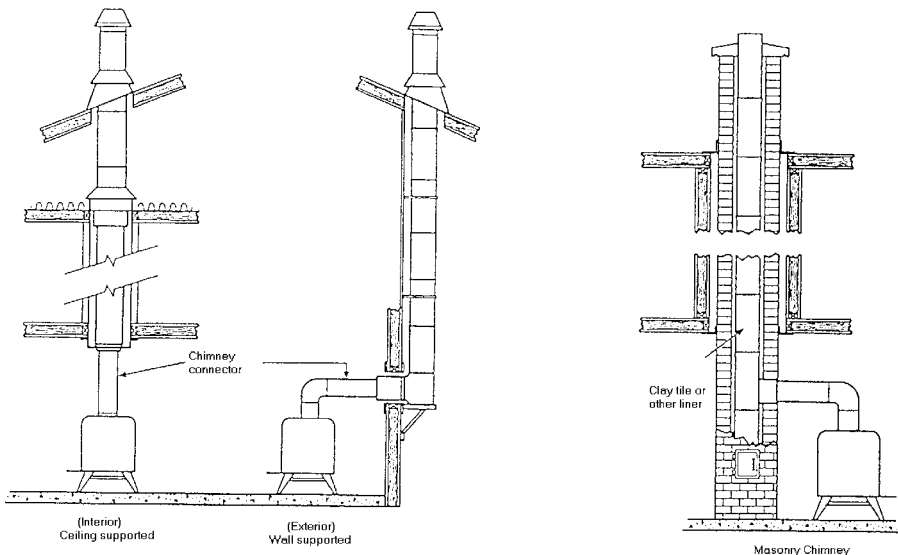

1.3 Flue Connection

The stove is supplied from the factory with a flue collar fitted to the top plate and a round blanking plate blocking off the rear flue exit (behind the rear shield plate).

Use a 24 MSG black or blue chimney connector or listed double wall chimney connector. Refer to local codes and the chimney manufacturer's instructions for precautions required for passing a chimney through a combustible wall or ceiling. Remember to secure the chimney connector with a minimum of three screws to the product and to each adjoining section.

The collar can be fitted to the rear outlet. Simply knock out the round panel on the rear heat shield plate to reveal the cast iron plate. Untwist the blanking plate and the flue collar and swap their positions. Re-secure by pushing down and tighten the enclosed screws. Position the stove and connect to the flue system.

Wear gloves and protective eyewear when drilling, cutting or joining sections of chimney connector.

1.4 Connection to the existing chimney

A chimney connector is the double-wall or single-wall pipe that connects the stove to the chimney. The chimney itself is the masonry or prefabricated structure that encloses the flue. Chimney connectors are used only to connect the stove to the chimney.

Double-wall connectors must be tested and listed for use with solid-fuel burning appliances. Single-wall connectors should be made of 24 gauge or heavier gauge steel. Do not use galvanized connector; it cannot withstand the high-temperatures that smoke and exhaust gases can reach, and may release toxic fumes under high heat. The connector must be 6 inches (150mm) in diameter.

If possible, do not pass the chimney connector through a combustible wall or ceiling. If passage through a combustible wall is unavoidable, refer to the sections on Wall Pass-Throughs. Do not pass the connector through an attic, a closet or similar concealed space when installing the chimney connectors.

It is important to keep the flue gases moving smoothly in the right direction. Do not vent into a large void at this location; rather form one continuous section all the way up. Use mild bends (e.g. 45° vs. 90°) rather than sharp angles where a change of direction is required. All parts of the venting must be accessible for cleaning purposes.

In horizontal runs of chimney, maintain a distance of 18 inches from the ceiling. Keep it as short and direct as possible, with no more than two 90 degree turns. Slope horizontal runs of connector upward 1/4 inch per foot (20 mm per metre) going from the stove toward the chimney. The recommended maximum length of a horizontal run is 3 feet (1 metre), and the total length should be no longer than 8 feet (2.5 metres).

Information on assembling and installing connectors is provided by the manufacturer's instructions exactly as you assemble the connector and attach it to the stove and chimney.

Be sure the installed stove and chimney connector are correct distances from near by combustible materials. See the clearance paragraph page 8.

Chimney Connector Systems and Clearances from Combustible Walls for Residential Heating Appliances

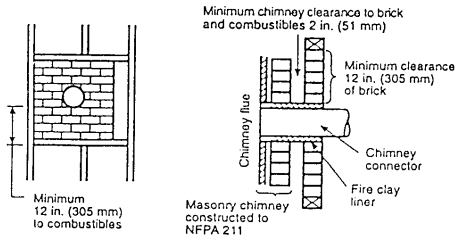

- A Minimum 3.5-in thick brick masonry all framed into combustible wall with a minimum of 12-in brick separation from clay liner to combustibles. The fireclay liner shall run from outer surface of brick wall to, but not beyond, the inner surface of chimney flue liner and shall be firmly cemented in place.

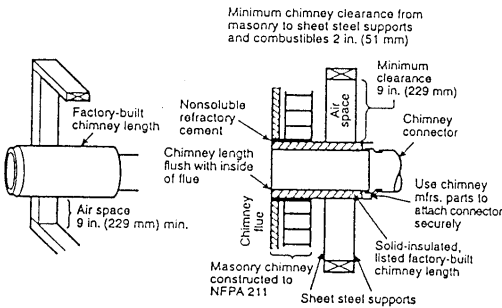

- B Solid-insulated, listed factory-built chimney length of the same inside diameter as the chimney connector and having 1-in. or more of insulation with a minimum 9-in. air space between the outer wall of the chimney length and combustibles.

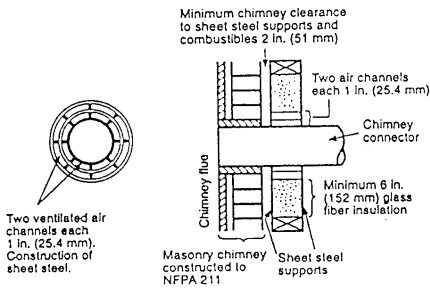

- C Sheet steel chimney connector, minimum 24 gauge in thickness, with a ventilated thimble, minimum 24 gauge in thickness, having two 1-in. air channels, separated from combustibles by a minimum of 6-in. of glass fiber insulation. Opening shall be covered, and thimble supported with a sheet steel support, minimum 24 gauge in thickness.

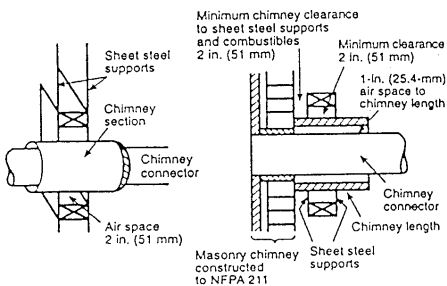

- D Solid insulated, listed factory-built chimney length with an inside diameter 2-in. larger than the chimney connector and having 1-in. or more of insulation, serving as a pass-through for a single wall sheet steel chimney connector of minimum 24 gauge thickness, with a minimum 2-in. air space between the outer wall of chimney section and combustibles. Minimum length of chimney section shall be 12-in. chimney section spaced 1-in. away from connector using sheet steel support plates on both ends of chimney section. Opening shall be covered, and chimney section supported on both sides with sheet steel supports securely fastened to wall surfaces of minimum 24 gauge thickness. Fasteners used to secure chimney section shall not penetrate chimney flue liner.

1.5 Positioning the stove

Distance to walls and intel

When the stove is positioned near combustible materials, observe all current local and national building regulations with regards to clearances. Whatever regulations apply to your area, do not in any case install the stove within 8 inches of combustible materials around the sides or 16 inches above the top of the stove. These distances may need to be increased if the materials are sensitive to heat. Note also that wall paper and other decorative materials may become detached with the effects of heat and care should be taken to ensure that they do not fall towards the stove in such an event.

When the stove is positioned near non-combustible materials, a gap of 4 inches or more is recommended for cleaning purposes and to ensure that heat circulates around the stove and out into the room.

MINIMUM CLEARANCES TO COMBUSTIBLES:
DEGAGEMENTS MINIMAUX AUX MATERIAUX COMBUSTIBLES:

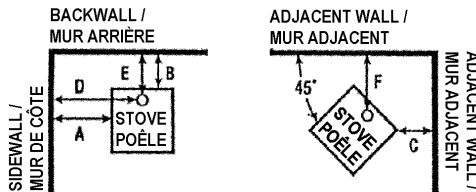

MORSØ 3410 & 3450 CLEARANCE REQUIREMENTS	STANDARD RESIDENTIAL INSTALLATION SINGLEWALL CONNECTOR	
	USA	CANADA
A. Sidewall to unit	16"	405 mm
B. Backwall to unit	12"	305 mm
C. Cornerwall to unit	12"	305 mm
D. Sidewall to connector	22.5"	570 mm
E. Backwall to connector	14.5"	370 mm
F. Cornerwall to connector	20"	510 mm
G. Unit to ceiling	-	-
H. Floor to ceiling	-	-

MORSØ 3440 CLEARANCE REQUIREMENTS	STANDARD RESIDENTIAL INSTALLATION SINGLEWALL CONNECTOR	
	USA	CANADA
A. Sidewall to unit	8"	205 mm
B. Backwall to unit	8"	205 mm
C. Cornerwall to unit	6"	150 mm
D. Sidewall to connector	16"	405 mm
E. Backwall to connector	10.5"	265 mm
F. Cornerwall to connector	13"	330 mm
G. Unit to ceiling	-	-
H. Floor to ceiling	-	-

FIREPLACE HEARTH INSTALLATION (alcove)
INSTALLATION DU FOYER (NICHE)

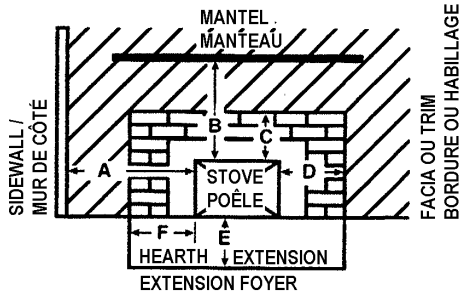

CLEARANCE REQUIREMENTS	STANDARD RESIDENTIAL INSTALLATION FIREPLACE HEARTH INSTALLATION (ALCOVE)	
	USA	CANADA
A. Sidewall to unit	-	-
B. Combustible mantel to unit	20"	510 mm
C. Top facing	19"	480 mm
D. Side facing	11"	280 mm
E. Hearth extending, front	-	-
F. Hearth extending, side	-	-

ALCOVE INSTALLATION / INSTALLATION ALCOVE

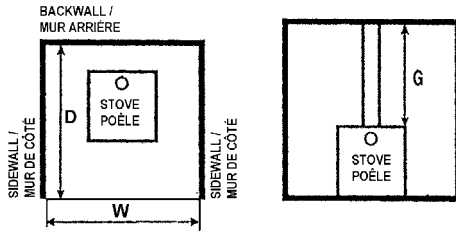

MORSØ 3410 & 3450 CLEARANCE REQUIREMENTS	ALCOVE INSTALLATOIN	
	USA	CANADA
W. Minimum alcove width	51"	1295 mm
D. Maximum alcove depth	31"	790 mm
G. Alcove ceiling above stove top	48"	1220 mm

MORSØ 3440 CLEARANCE REQUIREMENTS	ALCOVE INSTALLATOIN	
	USA	CANADA
W. Minimum alcove width	35"	890 mm
D. Maximum alcove depth	27"	685 mm
G. Alcove ceiling above stove top	48"	1220 mm

NON-COMBUSTIBLE FLOOR PROTECTOR:
PROTECTEUR DE PLANCHER INCOMBUSTIBLE

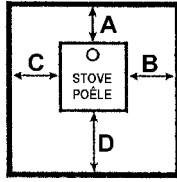

FLOOR PROTECTOR MUST BE NON-COMBUSTIBLE MATERIAL. IT MUST EXTEND BENEATH HEATER, AND TO THE FRONT/SIDES/REAR AS INDICATED.

LE PROTECTEUR DE PLANCHER DOIT ÊTRE D'UN MATÉRIEL INCOMBUSTIBLE. IL DOIT S'ÉTENDRE EN DESSOUS DE L'APPAREIL ET AU DEVANT, AUX CÔTÉS ET À L'ARRIÈRE DEL L'APPAREIL COMME INDIQUÉ.

FLOOR PROTECTION REQUIREMENTS	NON-COMBUSTIBLE MATERIALS BENEATH STOVE	
	USA	CANADA
A. Extending distance, back	-	200 mm
B. Extending distance, right side	6"	200 mm
C. Extending distance, left side	6"	200 mm
D. Extending distance, front	16"	450 mm

In the US, floor protection must be constructed of a non-combustible material and installed to extend beneath the heater and 16" to the front and 8" to the sides of the fuel loading door and ash removal openings. In Canada, floor protection must be constructed of a non-combustible material and installed to extend beneath the heater and 450 mm (16") to any side with a door and 200 mm (8") beyond the appliance on the other sides.

Distance to furniture

The recommended minimum distance from stove to furniture is 30 inches. Note that some furniture is more easily affected by heat and may need to be moved to a greater distance. This is your responsibility.

In addition other combustible materials, away from the stove. In general, a distance of 30 inches must be maintained between the stove and moveable combustible item such as drying clothes, newspapers, firewood etc.

1.6 Mobile Home Installation

The Morsø 3410, 3440 and 3450 can be installed in a mobile home if equipped with an outside combustion air kit, a terminal cap with a spark arrestor, and if it meets the following installation requirements:

- The stove must be secured to the mobile home structure by bolting through the hearth pad and into flooring.
- The stove must be installed with a listed Type HT chimney connector, HT Chimney, and terminal cap with spark arrestor. Never use a single wall connector (stovepipe) in a mobile home installation.
- Floor protection requirements in section 1.5 must be followed precisely.
- In Canada, this appliance must be connected to a 6" (152 mm) factory-built chimney conforming to CAN/ULC-629M, STANDARD FOR FACTORY BUILT CHIMNEYS. Floor protection as referenced in section 1.5 must be followed, as well as use of Canadian Floor Protector.

- Follow the chimney and chimney connector manufacturer's instructions when installing the flue system for use in a mobile home.
- Outside air kit should be installed according to installation guide in the kit.
- Intake air piping can be installed through the floor into a vented crawl space or through the wall of the residence to obtain outside air.
- Install in accordance with 24 CFR, Part 3280 (HUD).
- NOTE: Top sections of chimney must be removable to allow maximum clearance of 13.5' from ground level for transportation purposes.

WARNING:

NEVER DRAW COMBUSTION AIR FROM A WALL, FLOOR OR CEILING CAVITY OR FROM ANY ENCLOSED SPACE SUCH AS AN ATTIC OR GARAGE. DO NOT INSTALL IN A SLEEPING ROOM.

CAUTION:

THE STRUCTURAL INTEGRITY OF THE MOBILE HOME FLOOR, WALL, AND CEILING/ROOF MUST BE MAINTAINED (I.E., DO NOT CUT THROUGH FLOOR JOIST, WALL STUD, CEILING TRUSS, ETC.) DO NOT USE A GRATE TO ELEVATE FIRE - BUID FIRE DIRECTLY ON HEARTH.

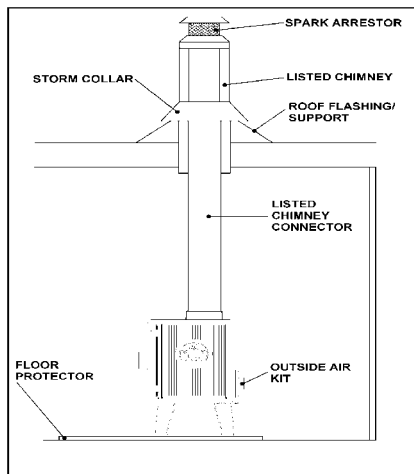

Note:

Acid Protection

If acid-washing the masonry around the stove, protect the stove surface with an acid-proof cover.

Fresh Air Inlet

Unless there is deemed to be sufficient ambient leakage of air into the room via doorways, windows and the like, a dedicated fresh air inlet will be needed. This inlet should have 2 square inches (1250 square mm) of free air space. This is particularly important where the room is well sealed, or where an extractor hood or ventilation system disturbs the natural air pressure. Such an inlet should not be on a wall that is usually subject to negative pressure from normal wind pattern. Avoid placing the inlet directly across the room from the stove, thus causing a cold air draft.

2.0 Operation

2.1 Before you start firing

For use with solid wood fuel only. Do not overfire, if heater or chimney connector glows you are overfiring. Inspect and clean chimney frequently. Under certain conditions of use creosote buildup may occur rapidly. Because of risk of smoke and flame spillage, operate only with door fully closed.

Caution:

Hot while in operation. Keep children, clothing and furniture away. Contact may cause skin burns.

Do not use chemicals or fluids to start the fire.

Do not burn garbage or flammable fluids.

Do not use gasoline, gasoline-type lantern fuel, kerosene, charcoal lighter or fluid or similar liquids to start or freshen up a fire in this heater. Keep all such liquids away from the heater while it is in use.

Choosing your fuel

All types of natural wood can be burned on your stove, but they must be well-seasoned and dry. Once the wood is cut to length, it should be split down middle - to suit the dimensions given below - to allow moisture to evaporate.

Cut the wood to a length of max 14 inches (35 cm) and approx. 3 to 3.5 inches (7-8 cm) in section. If you can weigh your wood, aim for around 2 lbs. For correct combustion and heat output, wood fuel should contain no more than 20% moisture; this can easily be checked by using the Morsø Moisture Meter (part # 6292900)

To naturally season wood fuel, stack and store it under cover in an airy location where fresh air can move through each piece. Some soft woods may take as little as one good summer to season whereas harder woods such as oak, maple, and elm may require seasoning up to 18 months. Avoid overly dry wood that is gray in color as under certain conditions it can cause performance problems, such as back-puffing and sluggishness. Well seasoned wood will be light to hold and will show signs of cracking from the center-out in the ends. If your wood spits or sizzles when burnt, and your stove's door glass persistently mists up, your wood is not properly seasoned. Never use drift wood (from the sea), whose salt content may cause corrosion, nor construction wood that may have been impregnated with chemicals.

Starting the first fire:

The initial fire should be small, so that the stove paint can cure and the main plates of the stove can settle into position. Some fumes will be given off by the paint. Ventilate the room during this phase.

The setting of the valve, lighting techniques and loading intervals will depend on chimney draft, the fuel used, the heat required and so on. Some basic techniques are outlined below.

In principle

Your stove is fitted with Primary and Secondary air inlets.

Primary Air is controlled using the lever situated under the ash lip of the stove. Moving the control lever into a downward position will open the air inlet and will allow a supply of preheated air to enter the firebox via the 'airwash' system situated inside the stove and the above glass.

Secondary Air is delivered to the firebox using the specially designed baffle at the back of the firebox. The secondary air is injected into the flue gases both above and in front of the fire resulting in a cleaner, more efficient combustion process. The supply of secondary air is fixed open and is not adjustable.

For extra safety, your stove has been fitted with a removable handle. When not in use the handle can be stored using the lug behind the right leg of the stove.

2.2 Lighting and loading intervals

When first lighting the stove, a large volume of air is needed. When the stove is cold, you should leave the door open an inch or two for the first few minutes and open the primary air supply completely. While the door is open, do not leave the stove unattended.

To form a reasonable bed of ash on the floor of the stove, you should use 5-6 inches thickness (2-4 pound) of dry kindling at the initial lighting. Always maintain a 1-1,5 inch (2-3 cm) layer of ash on the floor of the combustion chamber at all other times.

1. The air supply must be fully open.



2. Light the fire. An ember bed will quickly be formed by lighting with firelighters, Morsø kindling bags or 7-10 pieces of twisted paper under the dry kindling wood (see above).



3. After lighting, partially close the door, leaving it open an inch or two to allow in plenty of combustion air.



4. When the chimney is warmed through after 5-10 minutes, the door should be closed. A suitable ember bed will be formed after a further 15-20 minutes.



5. When ready to reload, use a poker to spread the ember across the firebox floor, bringing plenty towards the front of the stove.



6. Lay three pieces of wood (see dimensions above) onto the embers. Leave half an inch (1 cm) or more between each piece. Place the ends of your logs towards the opening, but not too close to the front.

7. Close the door. Leave the primary air supply fully open.

8. After a few minutes, and adjust the primary air supply to suit your heating requirements.

9. Anticipate each refueling, remembering to add a modest layer of wood while there are still plenty of live embers, Repeat steps 5-8.



Do not for any reason attempt to increase the firing of your heater by altering the air control adjustment range outlined in these directions.

Warning: Fireplace stoves must never be left unattended with doors open.

If the door is left partly open, gas and flame may be drawn out of the fireplace stove opening, creating risks from both fire and smoke. We recommend that you fit a smoke detector in the room where the stove is installed.

DO NOT OVERFIRE THIS HEATER. Overfiring may cause a house fire, or can result in permanent damage to the stove. If any part of the stove glows, you are overfiring.

The maximum recommended weight of wood fuel per load is 2.5 kg/h/5.5lbs (approx 3 split logs).

Under normal firing, the average flue temperature in the stove pipe, measured 20 cm above the stove, is approx. 300° C (550°F). The maximum flue temperature in the stove pipe must not exceed 450° C (750°F). If the flue temperature exceeds 450°C (750°F), it is considered as over firing and may cause premature wear and tear of the stove.

To help gauge the correct running temperature of your stove, we recommend you use the Morsø Flue Gas Thermometer (part # 62901200). The Flue Gas Thermometer magnetically attaches onto the stove pipe approx 20 cm (8") above the stove's top plate and measures the surface temperature of the stove pipe. Please see your authorized Morsø Dealer for availability.

Draft conditions

If smoke or fumes come out of your stove when lighting up and reloading, or if the fire simply will not respond, a poor draft is almost certainly to blame. (In a very few cases, there may be insufficient fresh air getting into the room - see installation advice above). Take advice from your stove supplier on how best to upgrade your flue system to improve draft.

Rules of woodburning

If you want less heat, put fewer logs on the stove and reduce the amount of air. It is still important to maintain a good layer of embers.

Less heat - less wood - less air

Greater heat - more wood - more air

Soot deposits will settle on the glass if the stove is run too slowly or if your wood is not well seasoned.

3.0 Maintenance

When performing maintenance on your stove, always protect yourself, using safety goggles and gloves

3.1 Exterior Maintenance

The stove surface is painted with heat-resistant Senotherm paint. It is best kept clean by vacuuming with a soft brush attachment or by wiping with a lint-free cloth.

Over a period of time, the painted surface may become slightly grey. A can of Morsø touch-up spray paint should be available from your stove supplier. This can be applied - in accordance with the instructions - in just a few minutes. When first firing after touching up, the stove will give off a slight smell as the paint cures. Make sure to ventilate the room well during this phase.

3.2 Internal maintenance

Glass

If the stove is generally run at the correct temperatures, there should be little or no dirt on the glass. If dirt does settle during lighting, most will burn off as temperatures increase. For heavier deposits that will not burn off, use Morsø glass cleaner, applied when the glass is cold, in accordance with the instructions. Never use abrasive cleaners on the glass surface.

Reasons for dirty glass

- Fuel too wet
- Logs too large or not split
- Combustion temperatures too low

Replace broken glass immediately.

Do not operate your stove if the glass in the door is damaged.

If you need to replace the glass, it should be replaced with the high temperature ceramic glass supplied by Morsø, contact your Morsø dealer.

Installing the glass

Never install the glass when the stove is in function.

Ceramic glass replacement

Ceramic glass cannot be recycled because it has a higher melting point than ordinary glass. If ceramic glass is mixed with ordinary glass, the raw material is spoiled, and the reclaiming process may be halted. Take care that the ovenproof glass does not end up among ordinary recycled waste. That will be a great benefit to the environment.

Note: Should be handed in to a recycling station as ceramic glass.

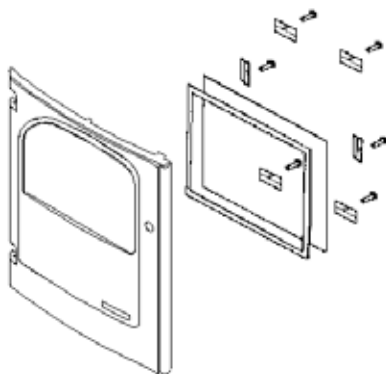

1. Lift the door off its hinges and place face-down on a sheet of cardboards or other non-abrasive fabric. The door is removed by loosening the 2 screws with a hexagon box wrench by the hinges.
2. Unscrew the eight bolts that secure the glass. (In the event that a bolt sheers off when being unscrewed, remove the remaining body of the bolt by drilling down its centre with 1/8 inch high speed steel drill bit. Smaller drill bits may be successful, but do not use a larger bit. Make sure the bit stays away from the edges of the bolt - this may damage the thread in the cast iron).
3. Remove the old ceramic gaskets and clean up the surface underneath with wire wool or emery paper to remove loose particles.
4. Place the new gasket material in position around the perimeter of the window area, making sure to pinch them to the length in such a way that they make a continuous seal. Leave no gaps.
5. Place the new glass in position on the strips and screw home the fresh bolts and fitting by hand.
6. Finally, give each of the bolts an extra half turn or so. The glass should be held tight enough by that cleaning will not dislodge it. Do not over-tighten the bolts as this may put excessive pressure on the glass, resulting in cracking - important!

To reduce the risk of breaking the glass, avoid striking the glass or slamming the door.

Internal service parts

The flame-path equipment - consisting of the ashpan, grate, firebricks, glass, baffle and flue collar - are subject to the extremes of heat produced by the fire. From time to time, one or other of these parts may need replacing as a matter of routine maintenance.

NOTE: The flame-path equipment, the ceramic rope and the paint finish are not covered by guarantee.

All of these service parts can be bought from your Morsø dealer, and we recommend that damaged parts are replaced as soon as possible to avoid collateral damage.

The grate may be replaced by lifting it by its left hand edge and twisting it backwards. Dislocate the riddling arm from the grate by feel from beneath the floor of the firebox. If you find this difficult for any reason, raising the rectangular grate surround casting may help.

Should the baffle be distorted by an overfire, the stove will still function, although its efficiency may be compromised. Replace it as soon as possible. The rear casing is removed (four bolts). Remove these and withdraw the baffle from the firebox (this may be easier if the firebricks are first removed).

Before replacing the baffle, scrape out the old fire furnace and replace with new to make an effective seal.

Reasons for fast internal wear and tear

Persistent heavy firing

Soot and ashes left to accumulate

Ceramic Gasket

The gasket around the perimeter of the door may harden over a period of time. It should be replaced if it becomes difficult to close the door or if air starts to leak in around the perimeter of the door, causing the fire to become a little less controllable. A Morsø rope gasket kit is available from your stove supplier.

3.3 Cleaning the Stove and the Flue

Check for soot above the baffle plate and around the flue outlet every month or so to start with. If the stove suddenly becomes sluggish, check for a soot fall around the flue collar or in the flue/chimney. - at least once a year. Inspect every month.

Clean the flue/chimney - all the way from the stove to the flue terminal point above the house. A good routine is to clean the flue after each heating season in any case, and inspect prior to the season to ensure that bird's nests or other blockages have not occurred during the off season.

Ash disposal

Empty the ashpan on a daily basis or as needed. Ash allowed to build up towards the underside of the grate will trap heat and could cause premature failure of the grate.

Empty the ashpan according to this procedure:

When the door is closed, the grate can be operated by means of the riddling bar. Open the front door, and use a shovel or poker to stir excess ash through the ash slots in the grate down into the ash pan. Remove the ash pan, making sure to keep it level.

Dispose the ash in a metal container with a tight fitting lid.

The closed container of ashes should be placed on a noncombustible floor or on the ground, well away from all combustible materials, pending final disposal. If the ashes are disposed of by burial in soil or otherwise locally dispersed, they should be retained in the closed container until all cinders have thoroughly cooled.

Return the ash pan to its original position in the stove, and close.

Caution:

Never empty a stove in operation.

Never use your household or shop vacuum cleaner to remove ash from the stove; always remove and dispose of the ash properly.

Creosote - formation and need for removal

When wood is burned slowly, it produces tar and other organic vapors, which combine with expelled moisture to form creosote. The creosote vapors condense in the relatively cool chimney flue of a slow-burning fire. As a result, creosote residue accumulates on the flue lining. When ignited this creosote makes an extremely hot fire. When burning wood, inspect the chimney connector periodically to determine if a creosote buildup has occurred.

Chimney sweeping

Inspect the system regularly during the heating season as part of a regular maintenance schedule. To inspect the chimney, let the stove cool completely. Then, using a mirror, sight up through the flue collar into the chimney flue. If you cannot inspect the flue system in this fashion, the stove must be disconnected to provide better viewing access.

Clean the chimney using a brush the same size and shape as the flue liner. Run the brush up and down the liner, causing any deposits to fall to the bottom of the chimney where they can be removed through the clean-out door.

Clean the chimney connector disconnecting the sections, taking them outside, and removing any deposits with a stiff wire brush. Reinstall the connector sections after cleaning, being sure to secure the joints between individual sections with sheet metal screws. If you cannot inspect or clean the chimney yourself, contact your local Morsø Dealer or a professional chimney sweep.

If you do experience a chimney fire, act promptly and:

1. Close the air control.
2. Get everyone out of the house.
3. Call the Fire Department.

Annual maintenance

Before the heating season, perform a thorough cleaning, inspection and repair: Thoroughly clean the chimney and chimney connector. Inspect the chimney for damage and deterioration. Replace weak sections of prefabricated chimney. Have a mason make repairs to a masonry chimney. Inspect the chimney connector and replace any damaged sections. Check gasketing for wear or compression, and replace if necessary. Check the glass for cracking; replace if needed. Check door and handles for tightness. Adjust if needed.

3.4 Leaving the stove for extended periods

Important:

If the stove is to be left unused for any period of time, clean it out thoroughly and leave the spinner slightly open to allow airflow. Make sure that the flue does not allow rainwater to come anywhere near the stove; install a chimney cap, but do not block off the flue completely. These measures should ensure there is a slight movement of air through the stove, and that the body of the stove remains dry, right into the corners. Any ash left within an unfired stove can attract moisture like blotting paper. If moisture is allowed to settle within the stove, rust will form. Rust expands as it takes a grip. This can lead to undue pressure on the stove joints, and this in turn may result in damage to the stove.

NOTE: It is best to thoroughly clean the stove after the heating season has concluded. Adding a dessicant, such as kitter litter, into the ash pan helps absorb moisture during the summer months. Be sure to remove this prior to the heating season.

Thank you for buying a Morsø stove.

We hope you have many years of carefree warmth in its company. Some initial experimentation with loading and running techniques will decide your normal routine. If you have any problems after this short learning phase, please refer to your stove dealer. Should they be unable to help for any reason, please contact us in writing at the address on the front of this publication.

3.5 Parts diagram for model Morsø 3400

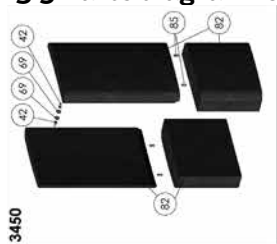

3450

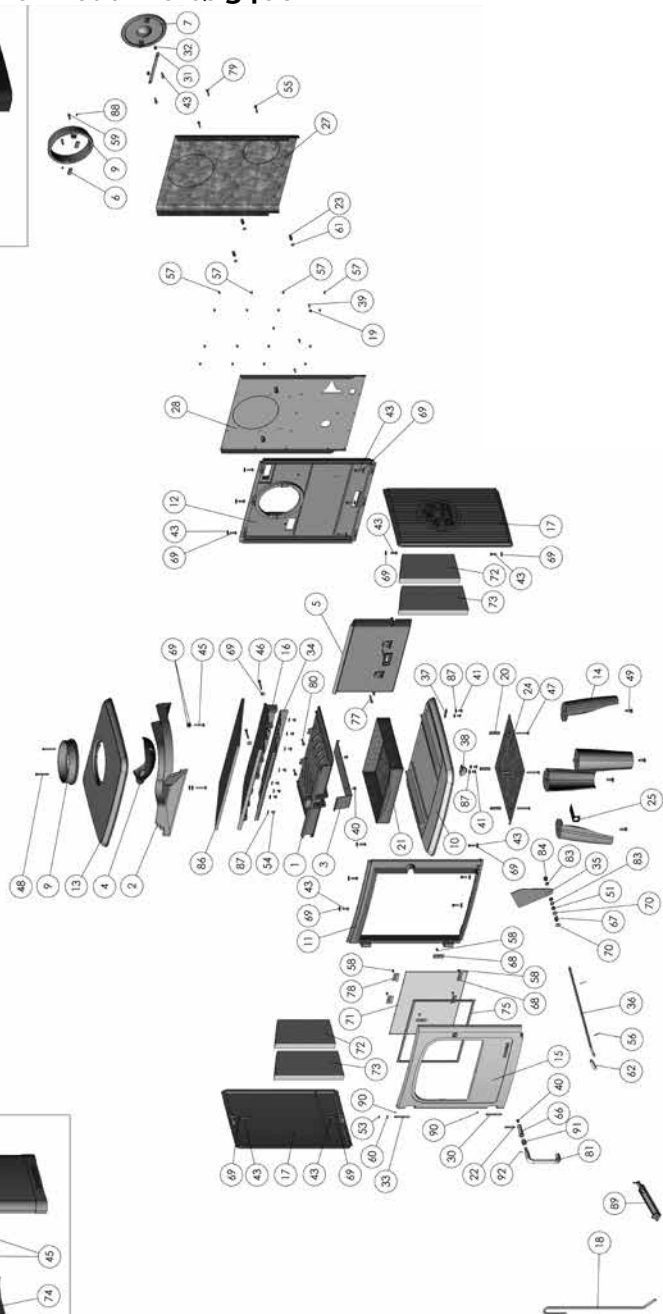

3410

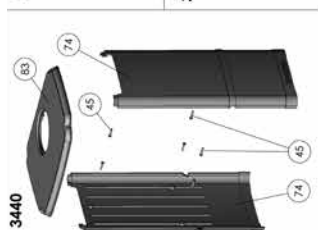

3440

3.6 Parts list for model Morsø 3400

No.	Parts	3410	3440	3450
1	Intermediate frame	44341800	44341800	44341800
2	Inside top plate	34340800	34340800	34340800
3	Plate for intermediate frame	71348000	71348000	71348000
4	Draft reducer	44342400	44342400	44342400
5	Inside rear plate	44341700	44341700	44341700
6	Fitting w. thread for flue collar	44256700	44256700	44256700
7	Cover	44261021	44261021	44261021
9	Flue collar	44344121	44344121	44344121
10	Base plate	44340121	44341421	44340121
11	Front frame	44342121	44342121	44342121
12	Rear plate, cast iron	44345121	44345121	44345121
13	Top plate	44340521	44341221	44341221
14	Leg	44340721	-	-
15	Door	44340921	44340921	44340921
16	Baffle plate, cast iron	44341900	44341900	44341900
17	Side plate w. owl	44344021	44341300	54340700
18	Poker	541075	541075	541075
19	Distance tube	54143700	54143700	54143700
20	Distance tube	54144400	54144400	54144400
21	Ash tray	541805	541805	541805
22	Hinge pin	542056	542056	542056
23	Distance tube	542635	542635	542635
24	Radiant shielding, bottom	54340000	54340000	54340000
25	Hanging for handle	54185800	54185800	54185800
27	Convection rear plate	54344521	54344521	54344521
28	Rear plate	54345221	54345221	54345221
30	Hinge pin	74701000	74701000	74701000
31	Flat bar	545006	545006	545006
32	Distance tube	545007	545007	545007
33	Hinge pin	545008	545008	545008
34	Baffle plate, stainless	71348100	71348100	71348100
35	draught control	71346300	71346300	71346300
36	Air inlet arm	71346400	71346400	71346400
37	Assemble steel	71346500	71346500	71346500
38	Assemble plate	71346600	71346600	71346600
39	Screw	73051600	73051600	73051600
40	Black steel set screw	731608	731608	731608
41	Black steel set screw	731610	731610	731610
42	Black steel set screw	731616	731616	731616
43	Black steel set screw	731620	731620	731620
45	Black steel set screw	731635	731635	731635
46	Black steel set screw	731640	731640	731640
47	Black steel set screw	731645	731645	731645
48	Screw	743650	743650	743650
49	Black steel set screw	731820	-	731820
51	Steel box	735008	735008	735008
53	o4 mm DIN 6799	791824	791824	791824
54	Screw	74160804	74160804	74160804
55	Screw	74143000	74143000	74143000
56	Cotter pin	74202000	74202000	74202000

3.6 Parts list for model Morsø 3400

No.	Parts	3410	3440	3450
57	Screw	74251800	74251800	74251800
58	Screw	73850800	73850800	73850800
59	Screw	743625	743625	743625
60	Brass washer	746006	746006	746006
61	Nut	74620500	74620500	74620500
62	Stainless handle for adjustment	75180400	75180400	75180400
66	Axis for handle	75462700	75462700	75462700
67	Stainless pressure spring	79048600	79048600	79048600
68	Glass fitting	54146261	54146261	54146261
69	Air slider washer	791891	791891	791891
70	Washer	79189400	79189400	79189400
71	Ceramic glass	79340000	79340000	79340000
72	Stone, side, back	79341400	79341400	79341400
73	Stone, side, front	79341300	79341300	79341300
74	Convection side plate	-	44341121	-
75	Tightening tape	79074500	79074500	79074500
77	Screw	74241900	74241900	74241900
78	Glass fitting	54146361	54146361	54146361
79	Screw	742525	742525	742525
80	Screw	74162000	74162000	74162000
81	Handle	54186100	54186100	54186100
82	Soapstone	-	-	79099439
83	Washer	79190000	79190000	79190000
84	Steel box nut	73520800	73520800	73520800
85	Dowel	-	-	541550
86	Insulation	79074600	79074600	79074600

Guarantee Product Registration

MORSØ 10 YEAR GUARANTEE CERTIFICATE

Behind every Morsø stove is more than 160 years of dedicated stove design and manufacturing experience. Quality control has always been at the heart of the production process and detailed measures have been put into place at all key stages of the build. Accordingly, provided that the stove has been supplied by an authorised Morsø dealer, Morsø will offer a 10-Year Manufacturers Guarantee against manufacturing defect to any of the main exterior body parts of its stoves.

**Read more about "Morsø 10 years guarantee/product registration card" and
REGISTER your new Morsø stove online:
<http://international.morsoe.com/warranty-registration>**

IMPORTANT!

How to heat safely for the environment and yourself!

- **Use only dry wood**

Use only dry (max. 20% moisture content) and untreated wood. The fuel must be split and 8 - 12 cm thick.

- **Light**

Light with dry kindling (use 1 - 2 kg). Leave the door ajar and stay close to the stove during the lighting phase.

- **Good layer of embers**

Be certain to have a good layer of embers before refilling. The wood should light within 2 minutes. If the logs do not ignite it may, in an extreme case, cause the flue gases to ignite which may pose a risk to material damage or personal injury.

- **Refuelling**

When refuelling use 2 - 3 pieces of wood - no more than 2 - 2.5 kg.

- **Ensure adequate air**

i.e. clear and yellow flames.

- **Never burn overnight**



By appointment to The Royal Danish Court

morsø

Morsø Jernstøberi A/S - 17.11.2015 - 72345400

MORSØ JERNSTØBERI A/S · DK-7900 NYKØBING MORS
E-Mail: stoves@morsoe.com · Website: www.morsoe.com